

Article number: 439500075  
 Description: Rota-fix shaft-hub connection F75x115  
 Steel  
 Note: Self centering. Very high torque

## Measures

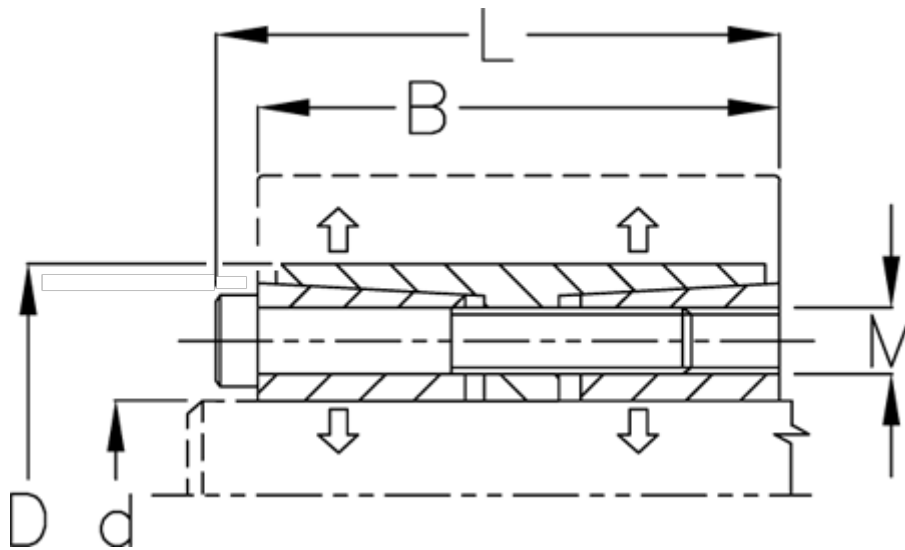

B mm	= 76
d H8 mm	= 75
D mm	= 115
Fit tolerance	= Aksel h8, Nav H8
F kN torque	= 280.0
L mm	= 86
M mm	= M10
P N/mm <sup>2</sup> surface pressure on shaft/hub	= 100

Surface roughness	= R? ? 3.2 µm
T N m torque	= 11000
Ts N m bolt tightening torque	= 83.0